



BOLERO



Das Muster **Bolero** unterscheidet sich wesentlich von allen anderen Mustern durch seine räumliche Expansivität, die markante Facette verstärkt den Raumeffekt. Geeignet auch als eine Ergänzung zu glatten Oberflächen für klassische sowie moderne Innenräume.











Abmessung: 22 x 22 cm





Empfohlene Plattsims-Modellreihen: Modern, Elegant

Empfohlene Glasuren: transparent sowie deckend, glänzend, matt, Effektglasuren



BOLERO

Artikel	Artikel - Nummer	Bezeichnung	Abmessungen in cm	Spezifikation	Gewicht (kg)	Fertigungs- Nummer	EH/Stück
	BO - C	Kachel BOLERO	22x22	-	2	0400 220002	1
	BO - P	Halbkachel	11x22	-	1,1	0400 220003	0,8
	BO - PP - R1	Halbecke R1	11x11x22	R 1,0	2	0400 220004	1,6
	BO- PP - R4	Halbecke R4	11x11x22	R 4,0	1,9	0400 220040	1,6
	BO - PP - R6,5	Halbecke R6,5	11x11x22	R 6,5	2	0400 220065	1,6
	BO - PP - 45	Halbecke 45°	11/11x22	45°	2	0400 220005	1,6
	BO - C - C	Putzkachel - komplett	22x22	viereckig	1,8	0400 220220C	1,4
	BO - C - CR	Einhängkachel	22x22	viereckig	1,2	0400 220220C1	0,8
	BO - C - V1	Lüftungskachel - Regelmäßige Nut	22x22	Lüftungsquer- schnitt 87 cm ²	1,7	0400 220220V1	1,2
	BO - C - V2	Lüftungskachel - Unregelmäßige Nut	22x22	Lüftungsquer- schnitt 77 cm ²	1,7	0400 220220V2	1,2
	BO - C - V5	Lüftungskachel - Gitter	22x22	Lüftungsquer- schnitt 102 cm ²	1,6	0400 220220V5	1,2

Artikel	Artikel - Nummer	Bezeichnung	Abmessungen in cm	Spezifikation	Gewicht (kg)	Fertigungs- Nummer	EH/Stück
	BO - C - V8	Lüftungskachel - Schrägnut	22x22	Lüftungsquer- schnitt 94 cm ²	1,7	0400 220220V8	1,2
	BO - C - V9	Lüftungskachel - Vertikalnut	22x22	Lüftungsquer- schnitt 118 cm ²	1,7	0400 220220V9	1,2
	KL - C - CV - 22	Einhäng- putzdeckel	16x16	viereckig	0,7	0100 220220C2	0,6
	KL - C - CV1 - 22	Einhäng- lüfterdeckel - Regelmäßige Nut	16x16	Lüftungsquer- schnitt 60 cm ²	0,6	0100 220220CV1	0,6
	KL - C - CV2 - 22	Einhäng- lüfterdeckel - Unregelmäßige Nut	16x16	Lüftungsquer- schnitt 53 cm ²	0,6	0100 220220CV2	0,6
	KL - C - CV3 - 22	Einhäng- lüfterdeckel - Würfel	16x16	Lüftungsquer- schnitt 26 cm ²	0,6	0100 220220CV3	0,6
	KL - C - CV4 - 22	Einhäng- lüfterdeckel - Flamme	16x16	Lüftungsquer- schnitt 39 cm ²	0,6	0100 220220CV4	0,6
	KL - C - CV5 - 22	Einhäng- lüfterdeckel - Gitter	16x16	Lüftungsquer- schnitt 54 cm ²	0,6	0100 220220CV5	0,6
	KL - C - CV6 - 22	Einhäng- lüfterdeckel - Motiv	16x16	Lüftungsquer- schnitt 31 cm ²	0,6	0100 220220CV6	0,6
	KL - C - CV8 - 22	Einhäng- lüfterdeckel - Schrägnut	16x16	Lüftungsquer- schnitt 48 cm ²	0,6	0100 220220CV8	0,6
	KL - C - CV9 - 22	Einhäng- lüfterdeckel - Vertikalnut	16x16	Lüftungsquer- schnitt 61 cm ²	0,6	0100 220220CV9	0,6

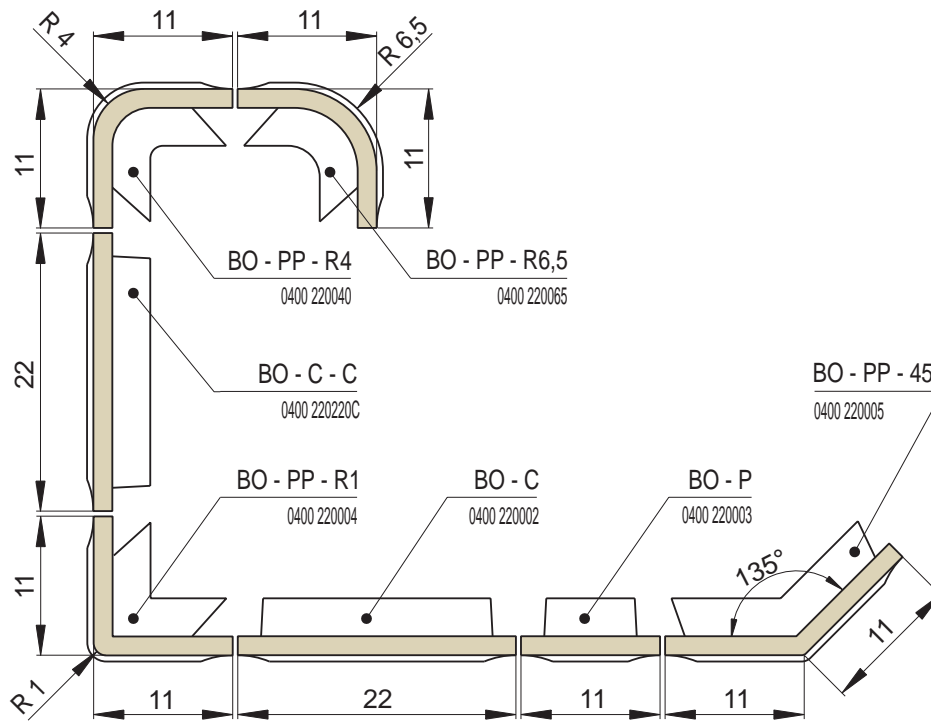
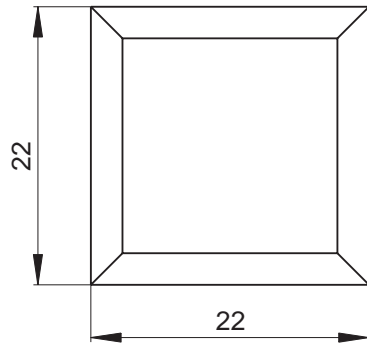



BO - C
Kachel BOLERO



BO - P
Halbkachel



BO - PP - R1
Halbecke R1



BO - PP - R4
Halbecke R4



BO - PP - R6,5
Halbecke R6,5



BO - PP - 45
Halbecke 45°



BO - C - C
Putzkachel - komplett



BO - C - CR
Einhängkachel



KL - C - CV - 22
Einhängputzdeckel



BO - C - V1
Lüftungskachel
- Regelmäßige Nut



BO - C - V2
Lüftungskachel
- Unregelmäßige Nut



BO - C - V5
Lüftungskachel
- Gitter



BO - C - V8
Lüftungskachel
- Schrägnut



BO - C - V9
Lüftungskachel
- Vertikalnut

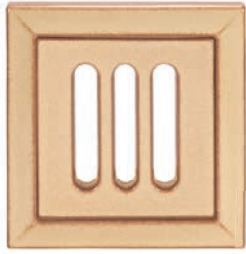

BO - C - CR
+ KL - C - CV1 - 22



BO - C - CR
+ KL - C - CV2 - 22



BO - C - CR
+ KL - C - CV3 - 22



BO - C - CR
+ KL - C - CV4 - 22



BO - C - CR
+ KL - C - CV5 - 22



BO - C - CR
+ KL - C - CV6 - 22



BO - C - CR
+ KL - C - CV8 - 22



BO - C - CR
+ KL - C - CV9 - 22