









Dem typischen historischen Muster **Akant** liegen künstlerische Details der Ofenmeister zugrunde. Geeignet für historische Säulenöfen mit Mittelsims sowie als zusätzliches Element für glatte Oberflächen, wo sein dekoratives Aussehen betont wird.

Abmessung: 22 x 22 cm

Empfohlene Plattsims-Modellreihen: Renaissance, Gotik

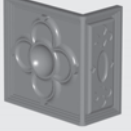
Empfohlene Glasuren: glänzend transparent, glänzende - halbgänzende Effektglasuren



Artikel	Artikel - Nummer	Bezeichnung	Abmessungen in cm	Spezifikation	Gewicht (kg)	Fertigungs- Nummer	EH/Stück
	AK - C	Kachel AKANT	22x22	-	1,8	1539 110006	1
	AK - P	Halbkachel	11x22	-	1	1539 113005	0,8
	AK - CP - R1	Eckkachel R1	22x11x22	R 1,0	2,6	1539 120011	1,8
	AK - PP - R1	Halbecke R1	11x11x22	R 1,0	1,4	1539 121005	1,6
	AK - C - K	Putzkachel - komplett	22x22	-	1,7	1539 110006C	1,4
	AK - C - V	Lüftungskachel	22x22	Lüftungsquer- schnitt 32 cm ²	1,6	1539 110006V	1,2

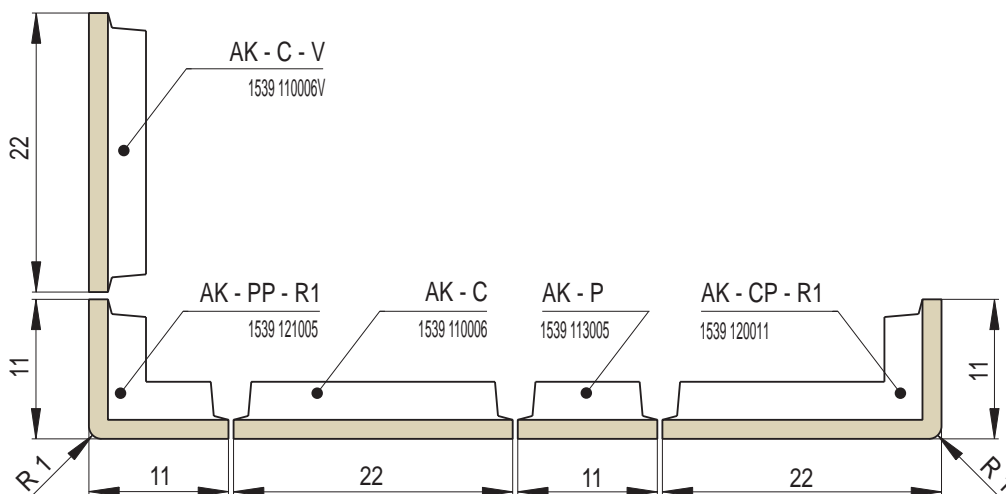
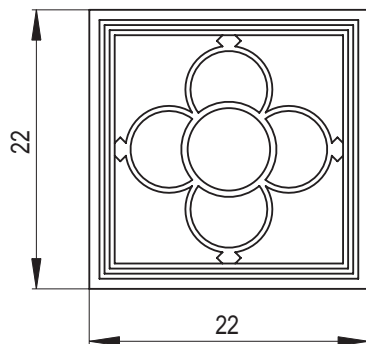



AK - C
Kachel AKANT



AK - P
Halbkachel



AK - CP - R1
Eckkachel R1



AK - PP - R1
Halbecke R1



AK - C - K
Putzkachel - komplett



AK - C - K
Putzkachel - komplett



AK - C - V
Lüftungskachel