

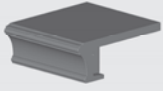

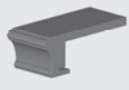

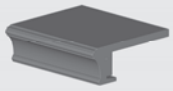





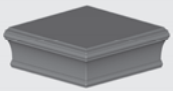

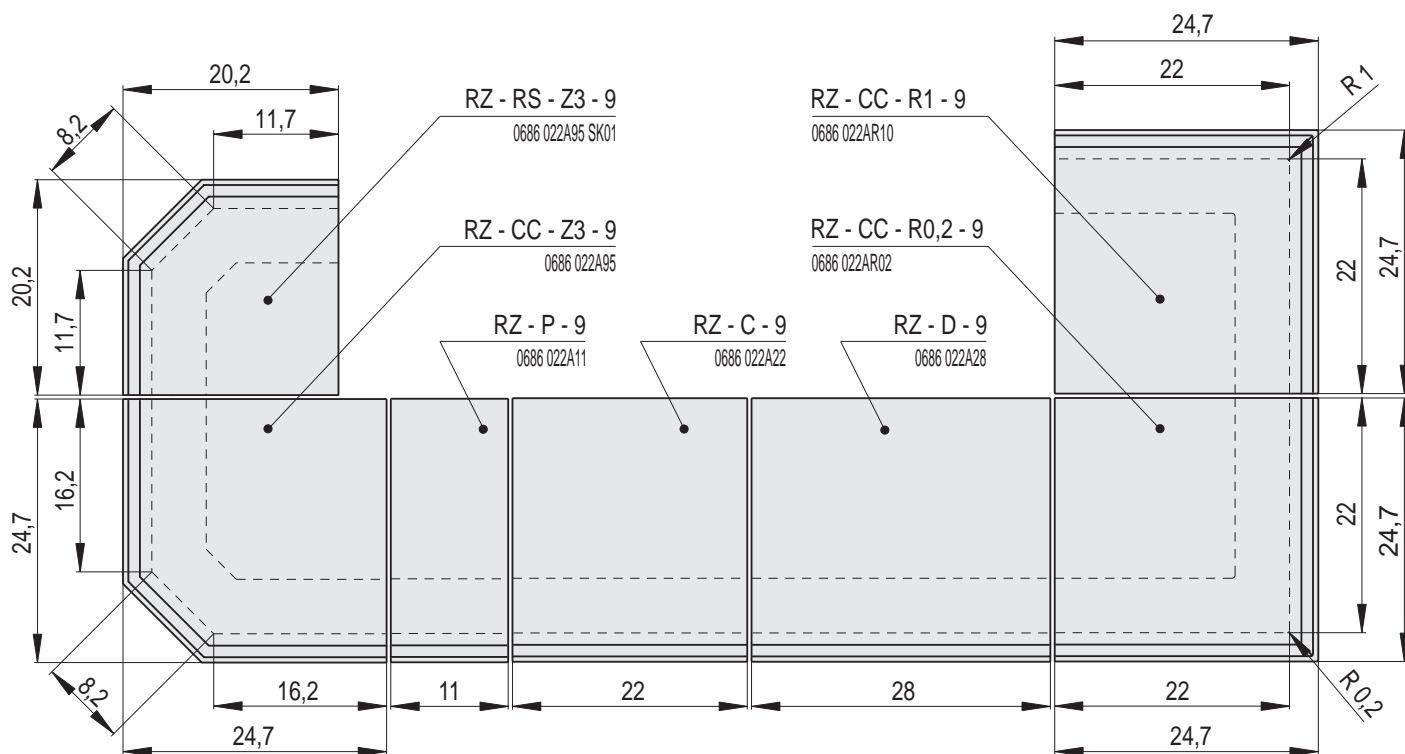
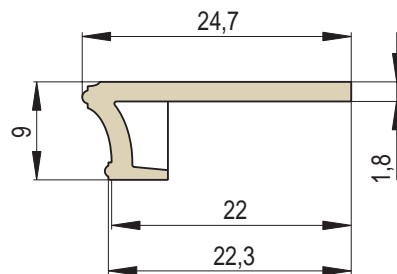
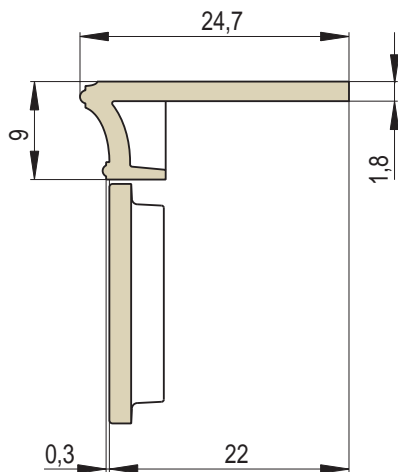

RENAISSANCE 9 | Plattsimsläufer / Höhe 9 cm

Artikel	Artikel - Nummer	Bezeichnung	Abmessungen in cm	Spezifikation	Gewicht (kg)	Fertigungs-Nummer	EH/Stück
	RZ - C - 9	Plattsimsläufer RENAISSANCE 9	22x22x9	-	2,8	0686 022A22	1,5
	RZ - P - 9	Plattsimsläufer halb	11x22x9	-	1,4	0686 022A11	1
	RZ - D - 9	Plattsimsläufer überlang	28x22x9	 28 cm	3,5	0686 022A28	1,8
	RZ - CC - R0,2 - 9	Plattsimsecke R0,2	22x22x9	R 0,2	3,8	0686 022AR02	2,2
	RZ - CC - R1 - 9	Plattsimsecke R1	22x22x9	R 1,0	3,8	0686 022AR10	2,2
	RZ - CC - Z3 - 9	Plattsimsecke Abschrägung Z3	22x22x9	Abschrägung Z3	3,5	0686 022A95	2,2
	RZ - RS - Z3 - 9	Plattsimsecke speziell Abschrägung Z3	20,2x20,2x9	Abschrägung Z3	3,4	0686 022A95 SK01	2,2



Abmessungen in cm.

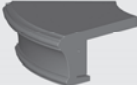

Artikel	Artikel - Nummer	Bezeichnung	Abmessungen in cm	Spezifikation	Gewicht (kg)	Fertigungs-Nummer	EH/Stück
	RZ - P25 - 9	Plattsims R25 - positiv	25/8x9		1,6	0686 022R25	1,5
	RZ - P29 - 9	Plattsims R29 - positiv	29,2/8x9		2	0686 022R29	1,5

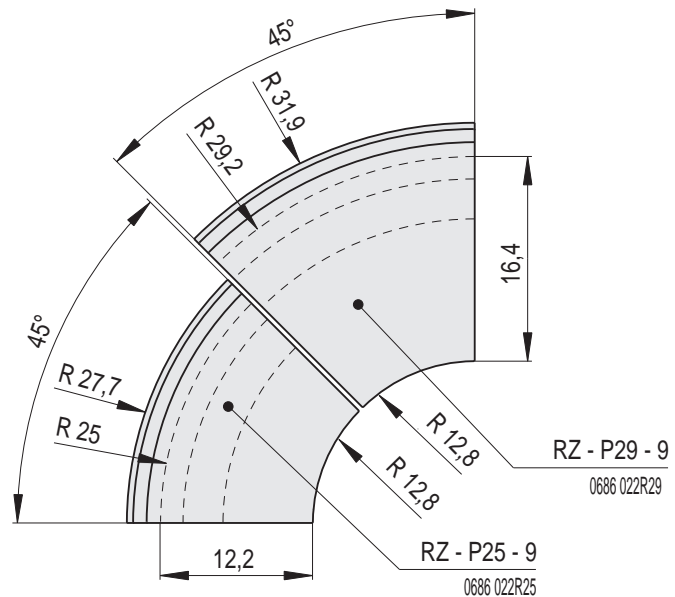
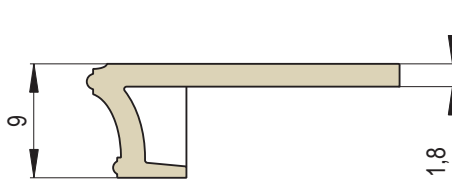

RZ RENAISSANCE 9 - Fotogalerie



RZ - C - 9
Plattsimsläufer
RENAISSANCE 9



RZ - CC - Z3 - 9
Plattsimsecke
Abschrägung Z3



RZ - P25 - 9
Plattsims R25
- positiv