

OZ

OP

OPTIM





OPTIM | Halbplattsimsläufer / Höhe 6 cm

Artikel	Artikel - Nummer	Bezeichnung	Abmessungen in cm	Spezifikation	Gewicht (kg)	Fertigungs- Nummer	EH/Stück
	OP - C	Halbplattsims- läufer OPTIM	22x11x6	-	1,6	0663 310140	1
	OP - P	Plattsimsläufer halb	11x11x6	-	0,8	0663 310011	0,7
	OP - D	Plattsimsläufer überlang	28x11x6	 28 cm	2	0663 310128	1,2
	OP - CC - R0,2	Plattsimsecke R0,2	22x22x6	R 0,2	2,8	0663 320R02	1,6
	OP - PC - R0,2	Plattsims links R0,2	11x22x6	R 0,2	1,9	0663 320R02L	1,6
	OP - CP - R0,2	Plattsims rechts R0,2	22x11x6	R 0,2	1,9	0663 320R02P	1,6
	OP - CC - R1	Plattsimsecke R1	22x22x6	R 1,0	2,8	0663 320R10	1,6
	OP - PC - R1	Plattsims links R1	11x22x6	R 1,0	1,9	0663 320R10L	1,6
	OP - CP - R1	Plattsims rechts R1	22x11x6	R 1,0	1,9	0663 320R10P	1,6

Artikel	Artikel - Nummer	Bezeichnung	Abmessungen in cm	Spezifikation	Gewicht (kg)	Fertigungs-Nummer	EH/Stück
	OP - CC - R4	Plattsimsecke R4	22x22x6	R 4,0	2,7	0663 320R40	1,6
	OP - PC - R4	Plattsims links R4	11x22x6	R 4,0	1,8	0663 320R40L	1,6
	OP - CP - R4	Plattsims rechts R4	22x11x6	R 4,0	1,8	0663 320R40P	1,6
	OP - CC - R6,5	Plattsimsecke R6,5	22x22x6	R 6,5	2,6	0663 320R65	1,6
	OP - PC - R6,5	Plattsims links R6,5	11x22x6	R 6,5	1,7	0663 320R65L	1,6
	OP - CP - R6,5	Plattsims rechts R6,5	22x11x6	R 6,5	1,7	0663 320R65P	1,6
	OP - PP - Z1	Plattsimsecke halb Abschrägung Z1	11/22/11x6	Abschrägung Z1	1	0663 011090	1,6
	OP - PP - 45	Plattsimsecke 45°	11x11x6	45°	1,4	0663 310045	1,6
	OP - PCP - 90	Plattsimsecke 90°	11/11x6	2x45°	2,9	0663 310135	1,2
	OP - PP - Z2	Plattsimsecke halb Abschrägung Z2	11x11x6	Abschrägung Z2	0,8	0661 331005	1
	OZ - C - Z2 - L	Plattsimsecke zu Z2 - links	22x22x6	Für LS Dekorleiste - Eckverbindung	2,1	0661 311010L	1,8
	OZ - C - Z2 - P	Plattsimsecke zu Z2 - rechts	22x22x6		2,1	0661 311010R	1,8

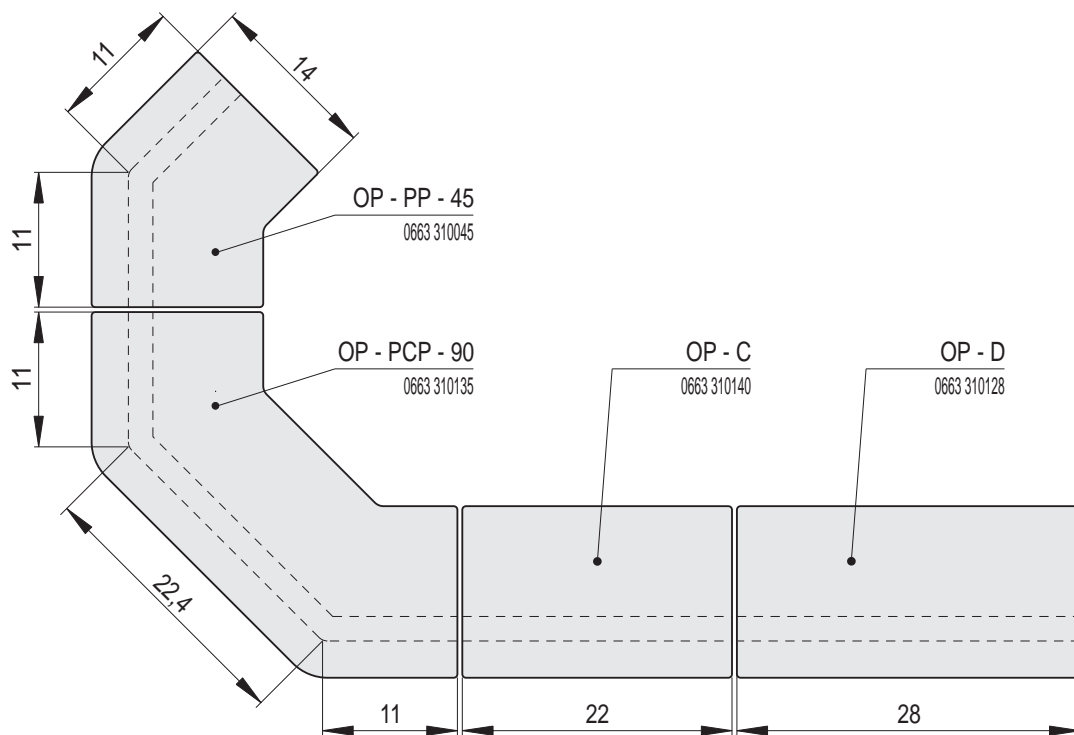
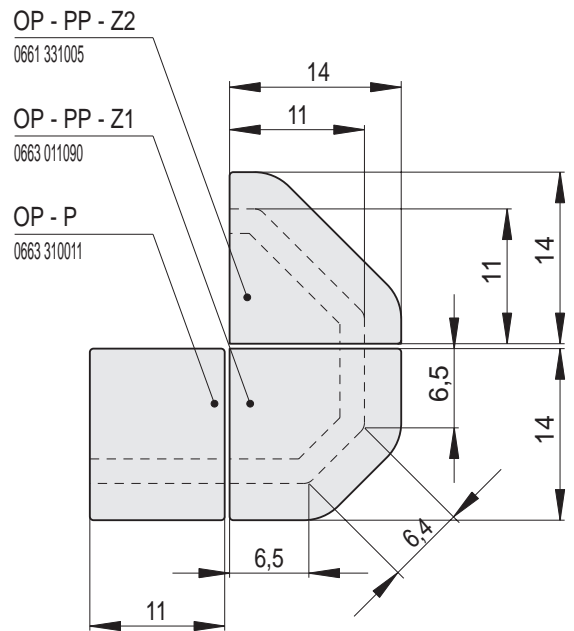
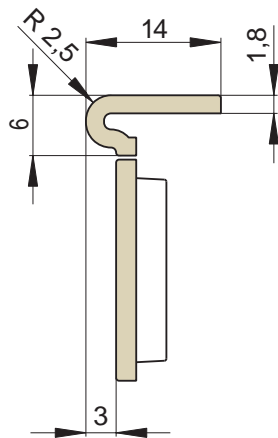

Abmessungen in cm.

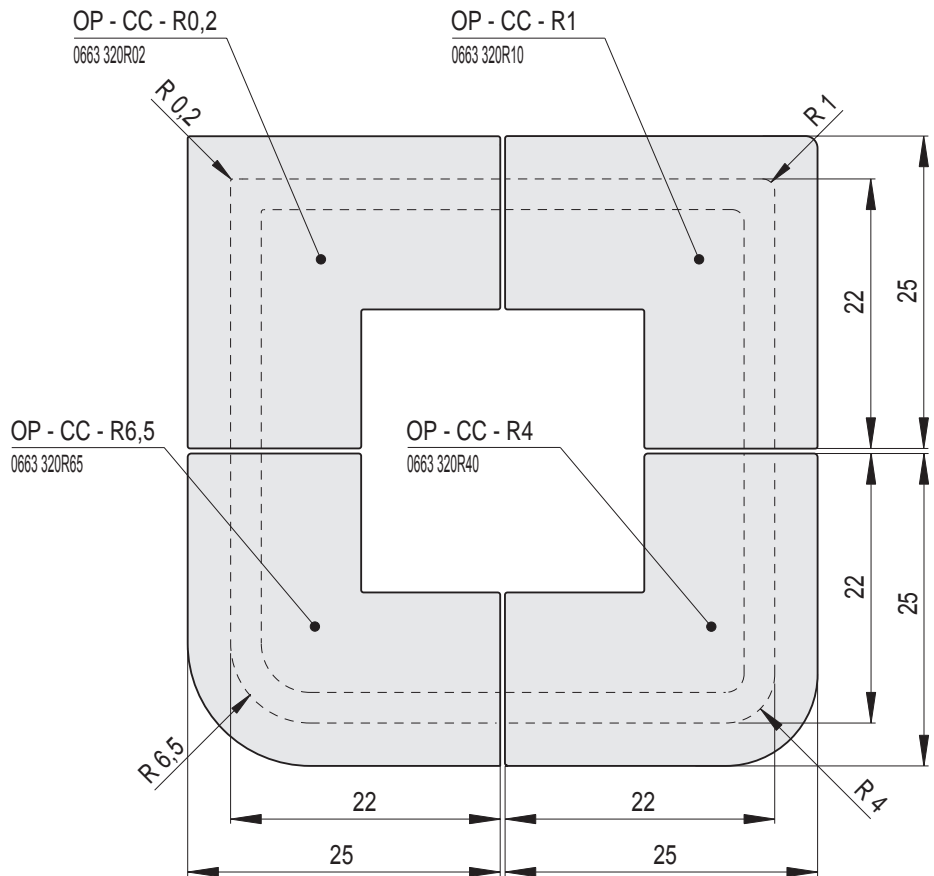
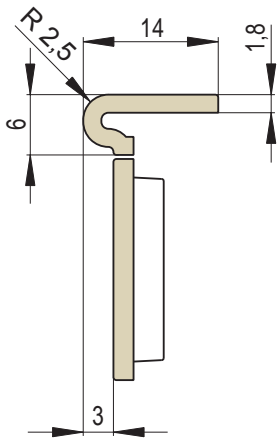

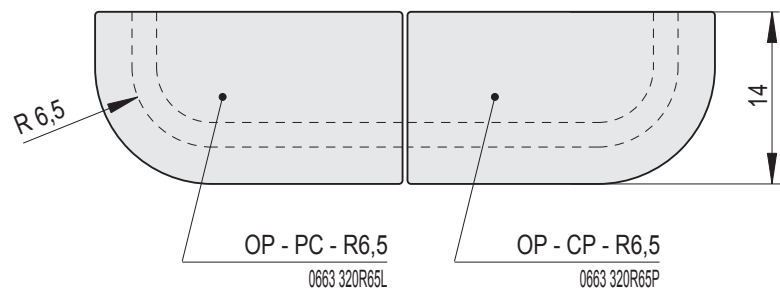
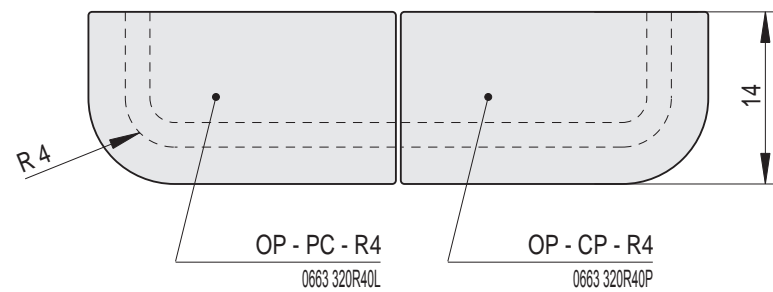
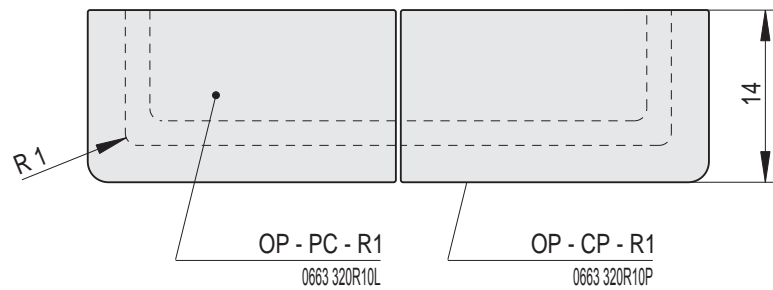
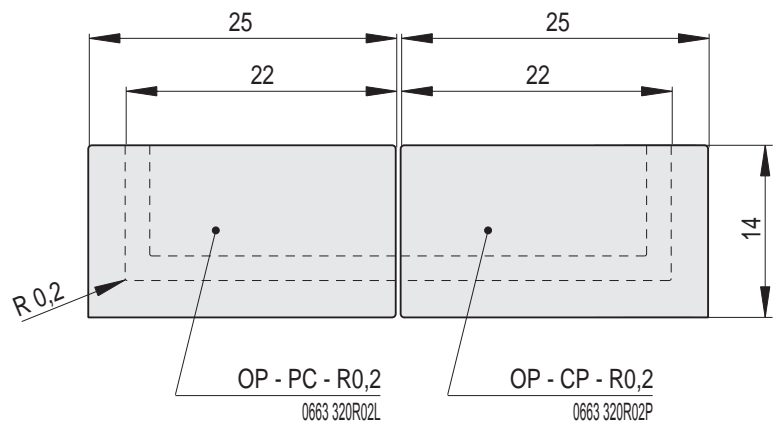
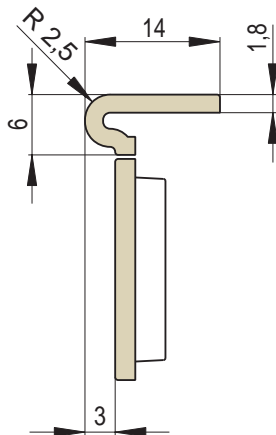

Abmessungen in cm.

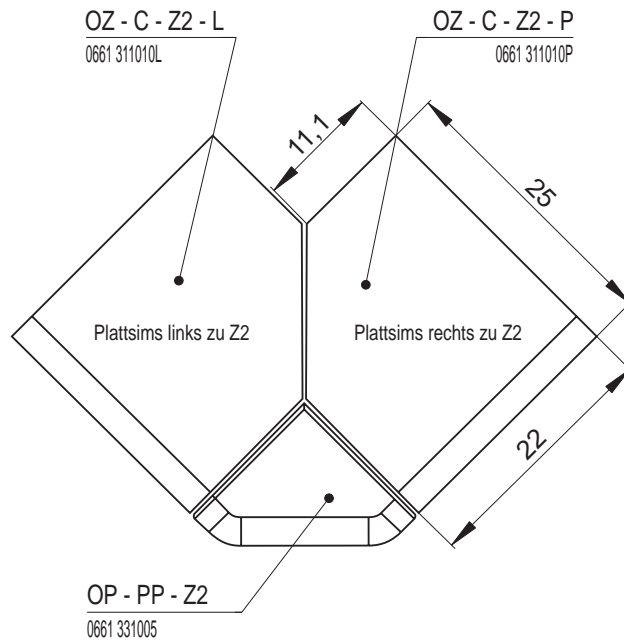
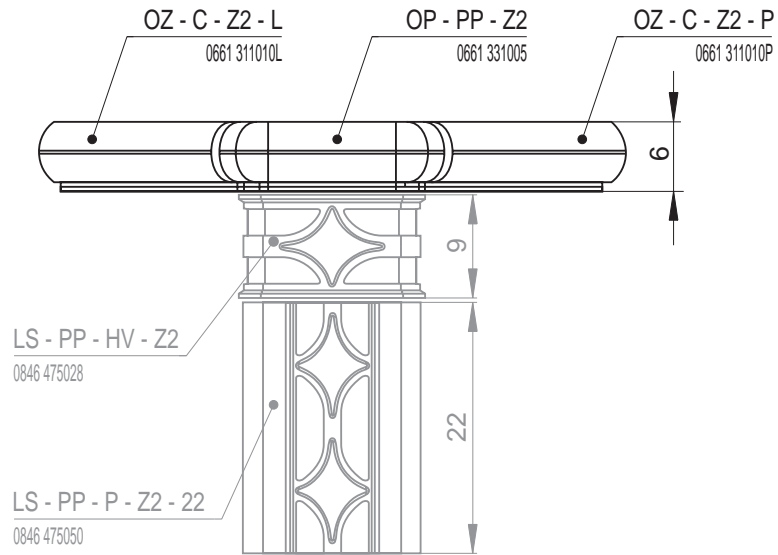



OZ - C
Plattsimläufer
OPTIM



OZ - D
Plattsimläufer überlang



OZ - CC - R1
Plattsimsecke R1



OZ - CC - R4
Plattsimsecke R4



OZ - CC - R6,5
Plattsimsecke R6,5



OZ - PP - 45
Plattsimsecke 45°



OZ - PCP - 90
Plattsimsecke 90°



OZ - CC - Z1
Plattsimsecke
Abschrägung Z1



OP - PC - R1
Plattsim links R1



OP - CP - R1
Plattsim rechts R1



OP - PP - Z1
Plattsimsecke halb
Abschrägung Z1



OZ - PP - Z2
Plattsimsecke halb
Abschrägung Z2



OP - PC - R4
Plattsim links R4



OP - CP - R4
Plattsim rechts R4



OP - PC - R6,5
Plattsim links R6,5



OP - CP - R6,5
Plattsim rechts R6,5



OZ - N34
Plattsim R34
- negativ



OZ - P86
Plattsim R86
- positiv



OZ - N79
Plattsim R79
- negativ